

ソロストーブ レンジャーがぴったり入る  
ポータブル グリル テーブル < 図面 >



designed by WORKS 真島辰也氏



収納時側面図

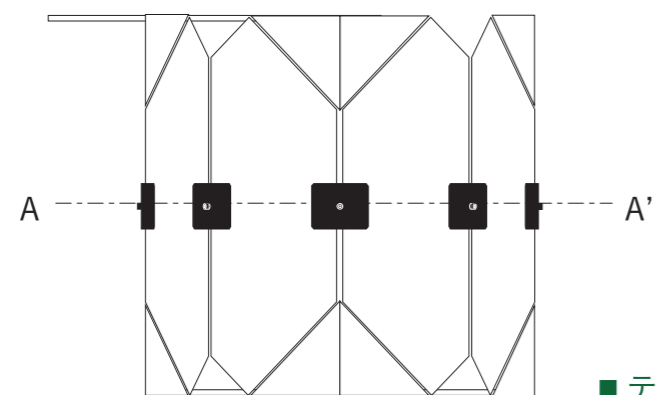

■ テツコウモリ 135° 8個

収納時平面図

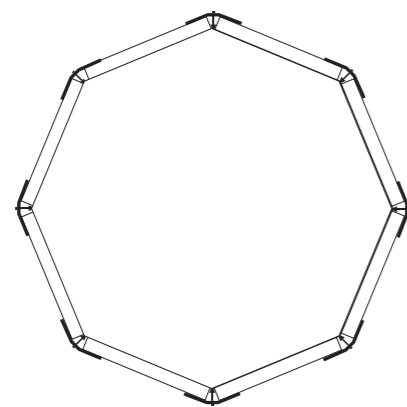

断面図 A-A'

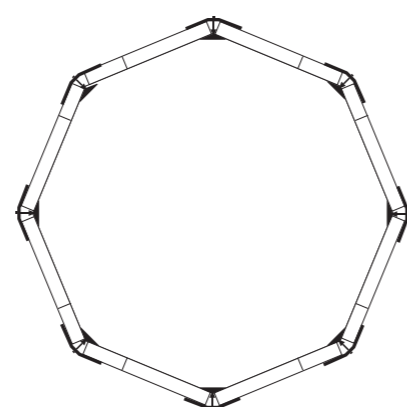

グリルテーブル平面図

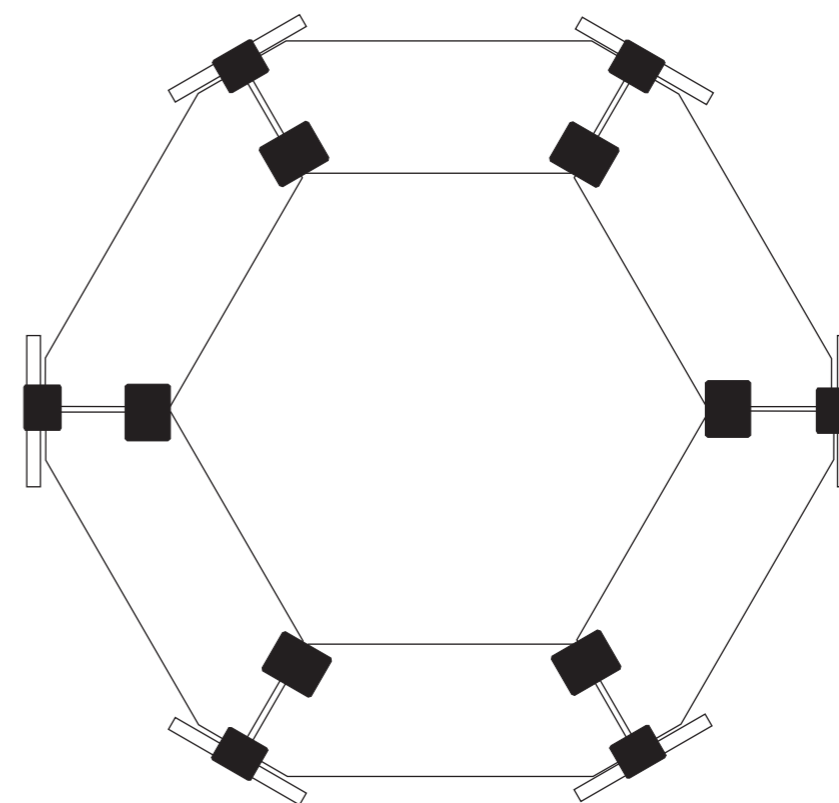

■ テツコウモリ 180° 6個  
■ テツコウモリ 90° 6個

テーブル天板

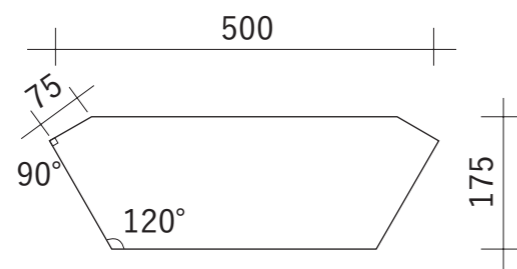

- ・グリルテーブル… 6枚使用
- ・ケース… 8枚使用

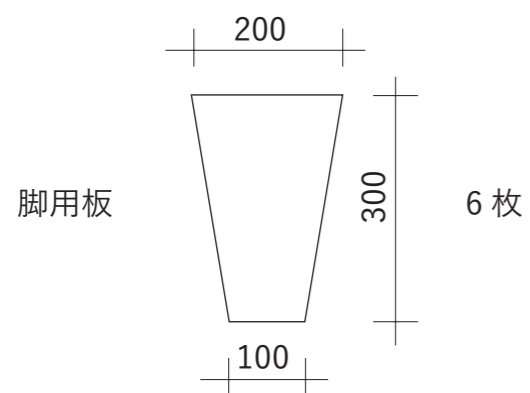

18mmの厚みの板を使用したときのサイズ例  
サンプルの場合は9mm MDF板を周囲のみ2枚使い

グリルテーブル側面図

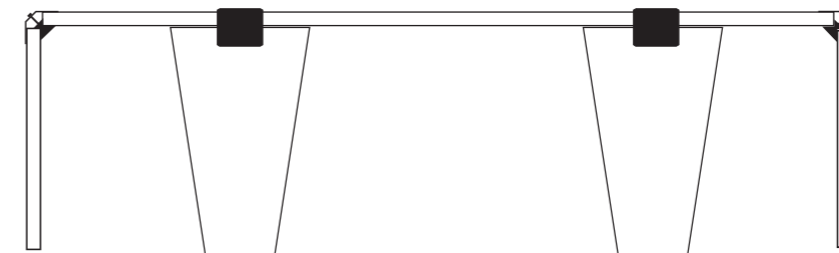

Scale 1:10

底板・天板図面

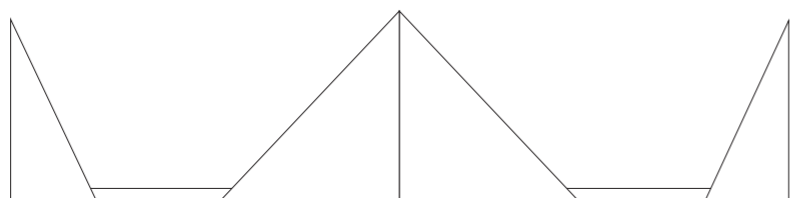
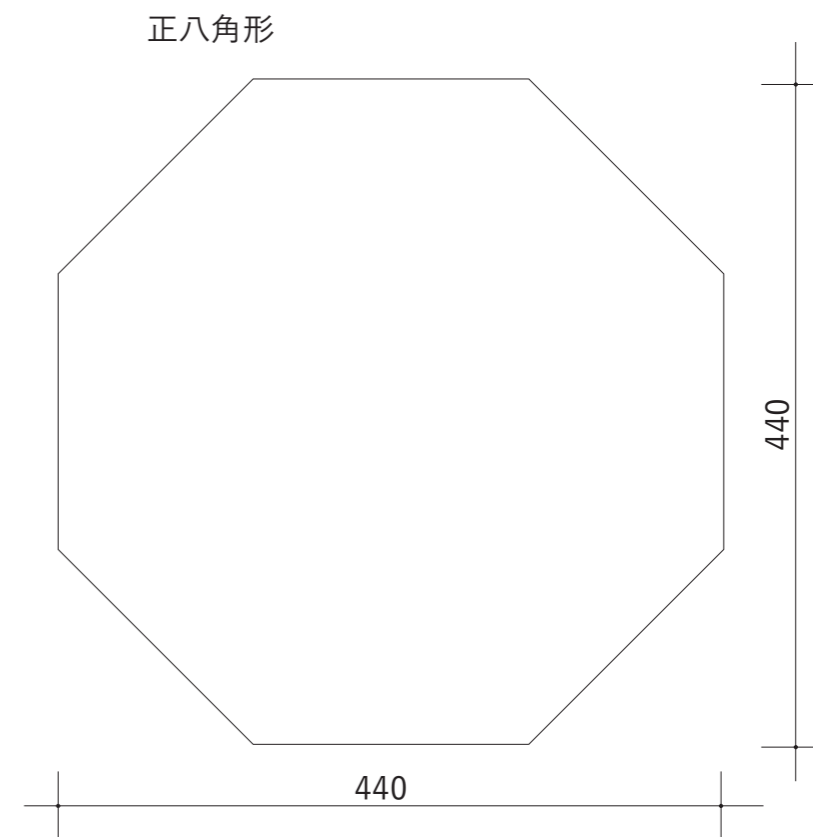
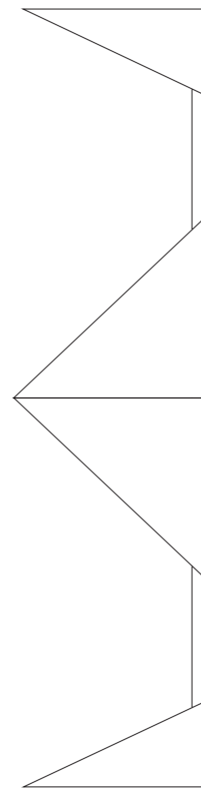
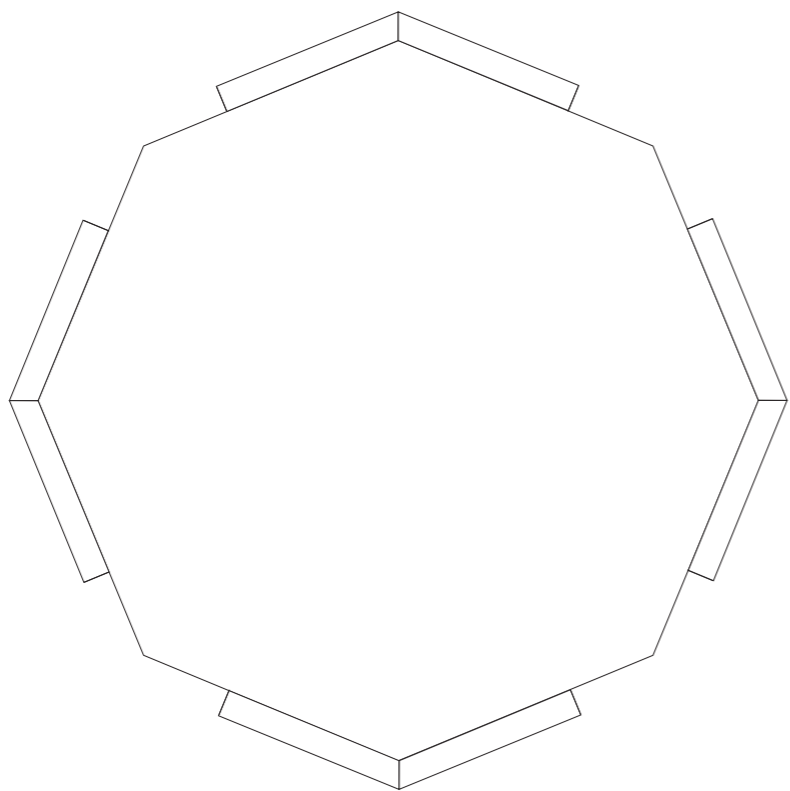

組み立てイメージ

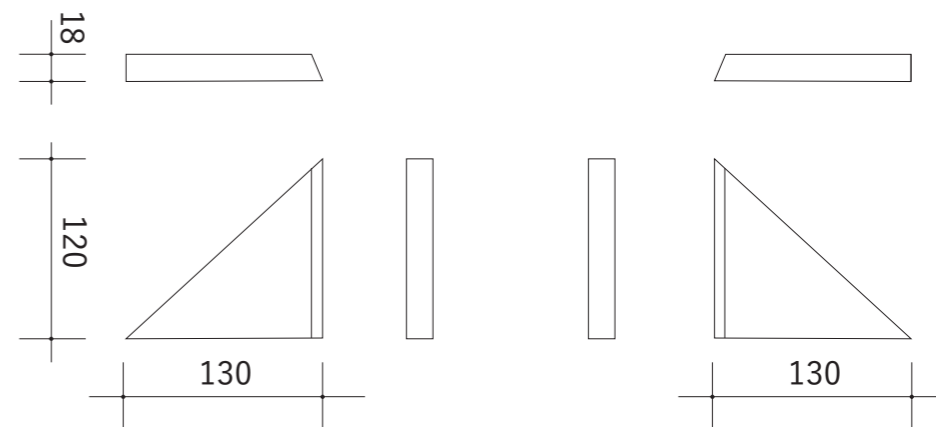
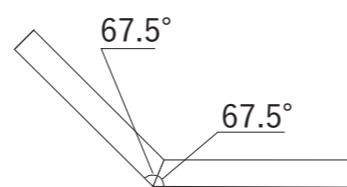

Scale 1:5